

AXIMA Performance™ - application-centric solutions

Proteomics suite

- Designed with the flexibility to adapt to users' workflow: from single sample manual acquisition to fully automated data-dependent peptide mass fingerprinting and MS/MS for protein identification.
- Peptide mass fingerprints are acquired and subjected to an optional integrated Mascot® database search.
- User defined acceptance limits for PMF-based protein identification.
- Data-dependent MS/MS: using the results of the PMF search, MS/MS may be performed on ions that matched to the top ranked protein hit (confirmation MS/MS), in addition to those that were not (investigation MS/MS). Batch searching of these MS/MS spectra is then performed automatically to provide further and higher confidence protein identification.
- Data may be reprocessed and resubmitted for database searching at a later time to provide additional information.

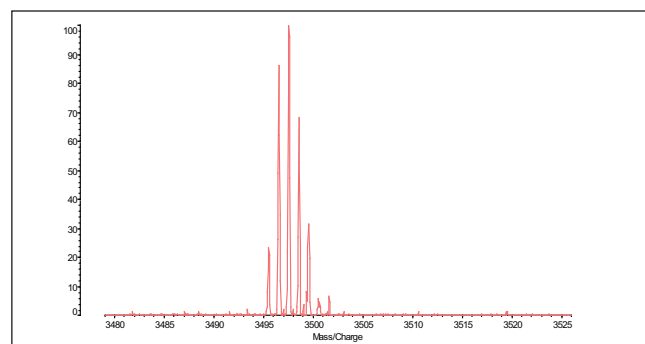

MS spectrum of Insulin B chain demonstrating resolution >20,000 (FWHM)

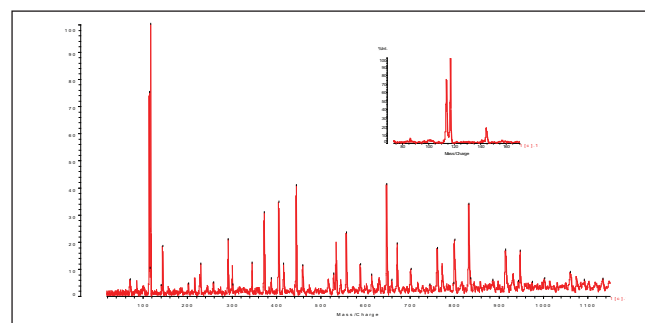

Typical example of an MS/MS spectrum obtained by automated acquisition

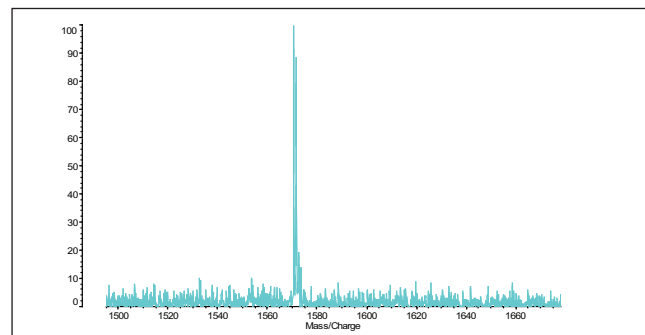

Peptide MS spectrum demonstrating attomole level sensitivity

LC-MALDI/Relative Quantitation experiments

- The Axima Performance™ provides total support for LC-MALDI based experiments.
- The software suite allows the fully automated acquisition of LC separated samples deposited onto MALDI targets and the subsequent identification of proteins via MS/MS of the peptides detected.
- The workflow automatically provides a provisional intensity map of all sample spots across the target to assess the distribution of peptides and identify the position of the apex of the chromatographic peaks. These are utilised to generate a candidate list and MS/MS data acquired for all discrete peptide ions.
- Exclusion lists are used to remove known contaminants or high abundance peptides.
- All data is then subjected to an integrated Mascot® search.
- Quantitation may also be performed on MS/MS based chemistries, using proprietary software providing valuable information regarding both the identity and relative amount of protein in a complex sample.
- Low sample consumption allows multiple spectra to be acquired from the same spot increasing the amount of MS/MS data obtained.

Biomarker Recognition/Tissue Imaging

- The Axima Performance™ allows full integration with the CHIP-1000™ matrix delivery system to allow seamless tissue imaging experiments
- Reproducible automated matrix delivery directly to the sample surface using the CHIP-1000™.
- Seamless export of sample location to the Axima™ MALDI mass spectrometer
- Automated acquisition of MS data – profiling or imaging
- Visualization of the spatial distribution of components of interest via intensity mapping software
- Easy export of data to alternative processing packages, including BioMAP

Additional application packages

- The system's flexibility and uncompromised linear mode performance also lends itself to alternative applications such as quality control.
- Launchpad™ software offers a module performing fully automated QC analysis of large numbers of oligonucleotides, peptides or small molecules, complete with a report indicating the presence or absence of a target compound, an estimate of the purity and occurrence of known contaminants, adducts or truncated/extended analogues.
- Polymer applications are also fully catered for using specifically developed polymer analysis tools suitable for use with both polymers and co-polymers.



SHIMADZU BIOTECH
bringing analysis to life

Mascot® is a registered trademark of Matrix Science Ltd., London, UK.

AXIMA®, AXIMA Performance™, LAUNCHPAD™, INTELLUMARQUE™, MonoPULSE™, Low Mass Zoom (LMZ)™ and Optimass™ are trademarks of Kratos Analytical Ltd., Manchester, UK.

Xcise™, Accuspot™ and CHIP™ are trademarks of Shimadzu Corporation, Kyoto, Japan.

AXIMA Performance™

Axima Performance - a highly flexible research grade mass spectrometer – from high energy MS/MS of proteomics and other biological and organic samples to uncompromised analysis of high mass intact proteins.

- True high energy MS/MS – CID with a laboratory frame collision energy of 20keV
- Optimal precursor ion selection resolution using revolutionary gating technology
- Outstanding sensitivity – uncompromised design, to ensure no MS/MS signal is discarded



www.shimadzu-biotech.net

info@shimadzu-biotech.net

SHIMADZU

E & OE Ref: MO300 Issue 1

SHIMADZU BIOTECH
bringing analysis to life

AXIMA Performance™ - the next generation in MALDI CID MS/MS

A high performance MALDI TOF-TOF mass spectrometer utilising state of the art high energy MS/MS, delivering unparalleled flexibility, in a robust and reliable research grade system.



- Highest energy collisions – CID with a laboratory frame collisional energy of 20keV
- Outstanding sensitivity – uncompromised design, to ensure no MS/MS signal is discarded
- Low sample consumption – allowing many more MS/MS experiments to be performed on the same sample spot
- Variable high repetition rate laser
- Optimal precursor ion selection resolution using revolutionary ion gating technology
- Manual or fully automated operation allowing the seamless analysis of few or many samples as required
- Fully enabled for proteomics experiments - Intellimarque™ software suite for automated data dependent peptide mass fingerprinting and MS/MS of peptides with optional incorporated Mascot® database searching
- LC-MALDI software allowing confident identification of off-line separated complex mixtures via automated MS/MS
- Can be utilized for any MS/MS quantitation chemistry

Essential features providing confident results

This next generation design MALDI system delivers all of the features expected of an AXIMA™ series mass spectrometer:

- High resolution MS data in reflectron mode for more accurate and confident peptide mass fingerprinting (PMF) and complex mixture analysis.
- Uncompromised linear mass range and sensitivity.
- Near-axis laser irradiation for enhanced ion transmission and sensitivity in all modes of operation.
- Advanced calibration algorithms with easy to use software providing more accurate data.
- Intuitive software incorporating data dependent workflows for achieving the maximum result with the minimum user input, making it ideal for novice and expert users alike.
- Flexibility – this is not just another proteomics workhorse. Polymers, oligonucleotides, SNPs, metabolites, carbohydrates and small molecules amongst others may all be analysed and processed.

Advanced MS/MS performance

The monoPULSE™ high performance, revolutionary ion gate provides outstanding MS/MS precursor ion selection resolution. When complex mixtures are analysed, the high resolution ion gate allows optimal isolation of ions with similar nominal mass, affording successful separation of MS/MS fragmentation patterns, producing more and higher confidence identifications. Resulting MS/MS spectra are easier to interpret and significant database search hits are more readily achieved. The high energy collisions, together with the new design Curved Field Reflectron produce well balanced, information rich MS/MS data.

- The unique combination of the advanced curved field reflectron design and the high energy collision cell means that all fragment ions formed are detected, regardless of where they are formed in the instrument. Both LID and CID ions are accumulated into a seamless spectrum providing the best possible MS/MS sensitivity.
- The Low Mass Zoom™ feature allows rapid enhancement of the region of the spectrum encompassing the immonium ions and isotopically labeled quantitative diagnostic ions.
- Gridless ion path, unique to leading MS/MS systems, designed to avoid unwanted ion scattering and ensure the highest possible ion transmission.
- High sensitivity allowing multiple MS/MS acquisitions on the same sample spot through low sample consumption.

AXIMA Performance™ - high performance in a robust and flexible design

A practical and ergonomic package

The compact floor-standing geometry is designed to maximise laboratory space and allow easy installation and servicing. The system is delivered ready to install requiring little assembly on site.

Attention has been paid to the important factors of cost of ownership and lifetime operational costs, minimising the risk to the investor. The system has undergone the most rigorous and extensive quality assurance program, to ensure high reliability and robustness, in the best Shimadzu tradition.

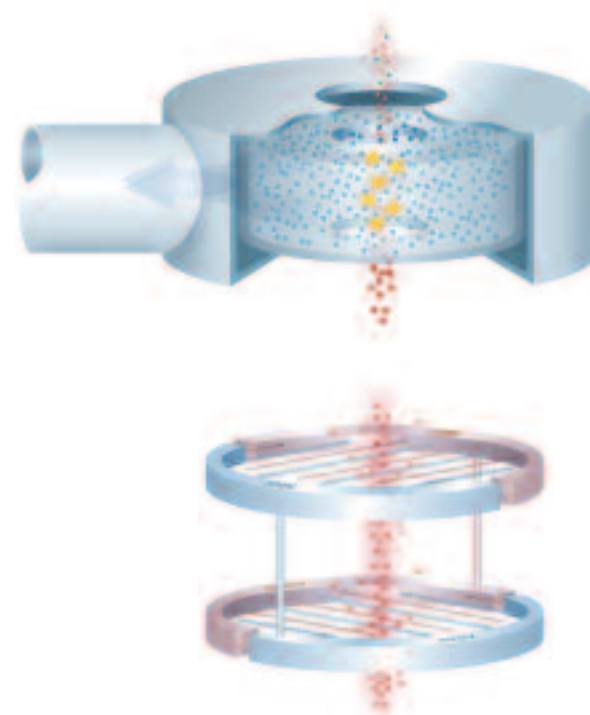

As with all AXIMA™ series systems, industry standard microtitre plate format MALDI targets are used for convenience and simple experimental planning and tracking. This allows seamless integration with a variety of robotic sample handling systems including the Xcise™, Accuspot™ and the ChIP™.

Modular target adaptors permit the use of many different sample target formats including, Fleximass™ and other microscope slide formats, in addition to a wide array of biochips.

All Axima systems can be fully supported throughout their lifetime using sophisticated web based service diagnostics and real time remote monitoring. Highly trained specialist local service support engineers are available to install and maintain Axima mass spectrometers. A wide range of service contracts are available, catering for all budgets and requirements, including IQ/OQ environments and high throughput QA laboratories.

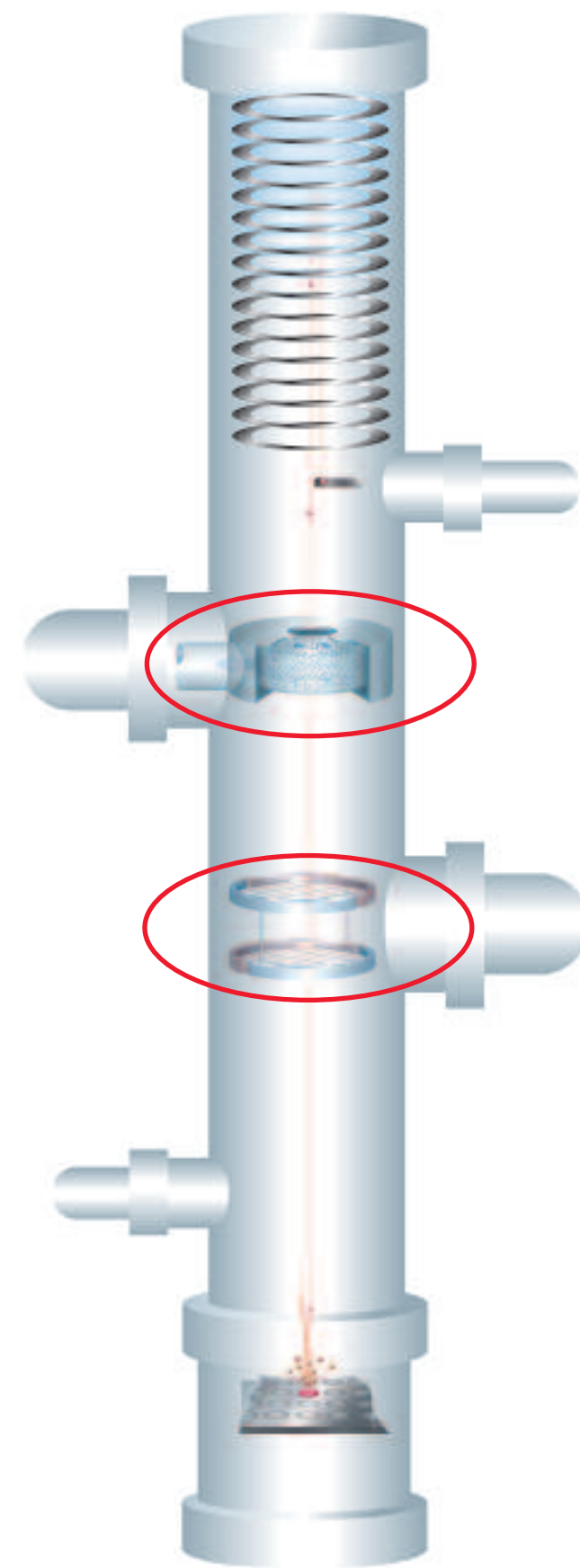

AXIMA Performance™ - excellence without compromise

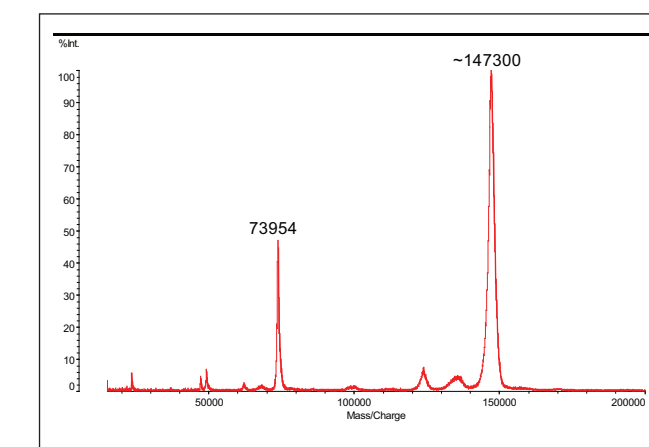

Linear MS spectrum of Immunoglobulin G.

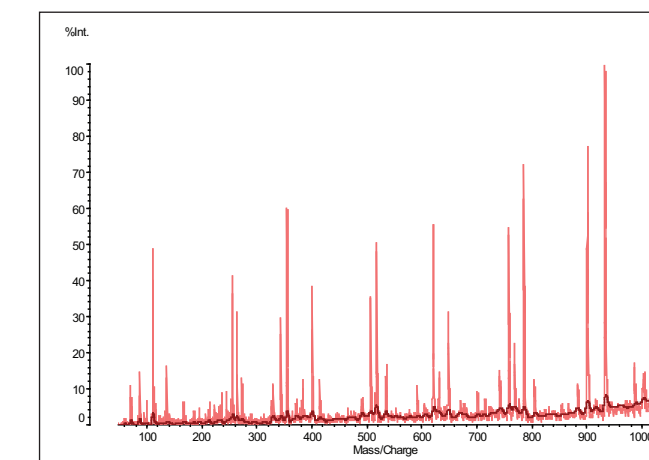

Typical high energy CID MS/MS spectrum

High performance MS data :

The Axima Performance™ demonstrates high resolution and mass accuracy across a wide mass range, from pharmaceutical compounds, through peptides to high mass proteins, to enable a variety of applications in the research environment. A highly optimised linear mode generates reproducible and sensitive results for very high mass compounds and complexes, extending the array of sample classes that may be analysed. A typical example of an intact high mass protein, Immunoglobulin G, is shown here.

Powerful precursor ion selection :

The revolutionary monoPULSE™ ion gate allows the selection of MS/MS precursors with industry leading resolution. Ions from complex mixtures or closely associated neighbouring isotopic envelopes may be isolated and subsequently fragmented. The gate resolution of greater than 400 (FWHM) readily permits the analysis of peptides with similar nominal mass, even with overlapping isotopic distributions.

Efficient MS/MS from high energy CID :

Once selected for MS/MS fragmentation, precursor ions are subjected to true high energy collisions with the chosen collision gas, e.g. helium. The resulting fragment ions are analysed in the second TOF region incorporating the curved field reflectron and detected with the ultrafast MCP detector.

Typical MS/MS spectra shown here display the quality and sensitivity of a routine analysis. Detailed information is gained from a wide range of fragment ion masses and intensities. The increased intensity of the immonium ions adds confidence through diagnostic value to peptide sequence assignment and significantly aids de-novo sequencing experiments.

The novel additional LMZ scan allows focus of the analysis to be directed around the low mass region of the MS/MS spectrum. This feature can be employed to increase confidence in MS/MS based quantitation experiments and to aid in de novo sequencing of unknowns by enhancing the immonium ion region of the spectrum.